

ELECTRIC PUMP EL35

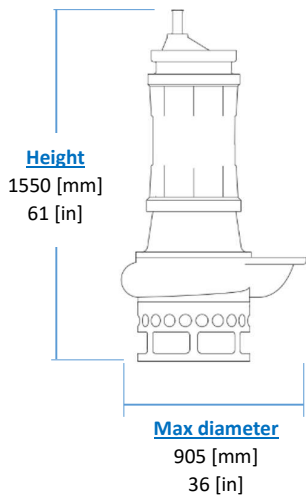
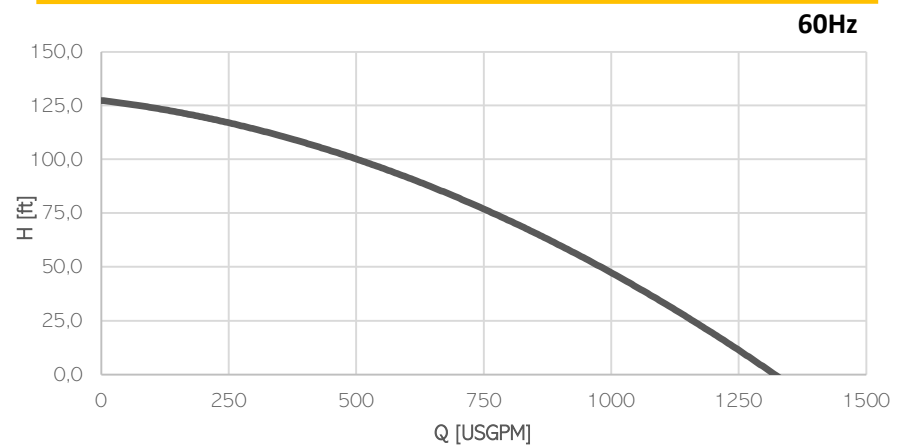
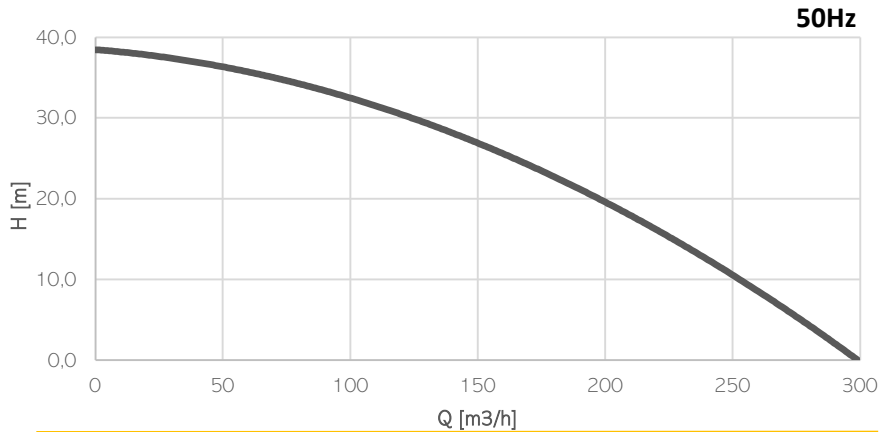

KG
Weight
(without cable)
780 [kg]
1580 [lb]

Electrical motor

Insulation class H

Cable

1 x H07RN-F 4G16 length 20m

Operating Conditions

- Max liquid temperature 35°C
- Min Submersion depth 1240 mm

Model	EL35	
Brake Power [kW HP]	26 35	
Electric Power [kW HP]	28 38	
Frequency [Hz]	50	60
Efficiency [%]	53%	52%
Number of Poles	6	6
RPM	970	1164
Voltage [V]	400	460
Rated Current [A]	55	47
Solid handling [mm in]	35 1.4	
Discharge [DN-PN]	100-10	

Materials

Part	Standard
Casing	Cast Iron EN-GJS500
Body	Cast Iron EN-GIL250
Wear Parts	High chrome EN-GJN-HV600 (CH6)
Minimum hardness [HB]	550
Main shaft	High tensile 39NiCrMo3
PH Range	5-10

Seals and lubricants

Version	EL35	MG	MS
Motor Side	LIPS	MECHANICAL	MECHANICAL
Impeller Side	LIPS	LIPS	MECHANICAL
Oil type	EP320	ISO32	ISO32