

POMPA ELETTRICA EL25S

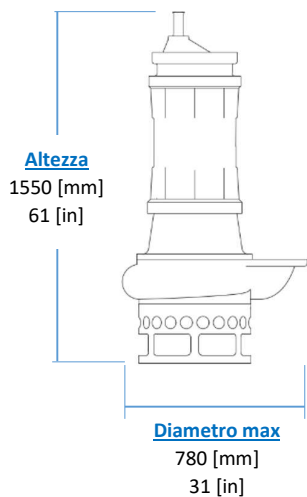
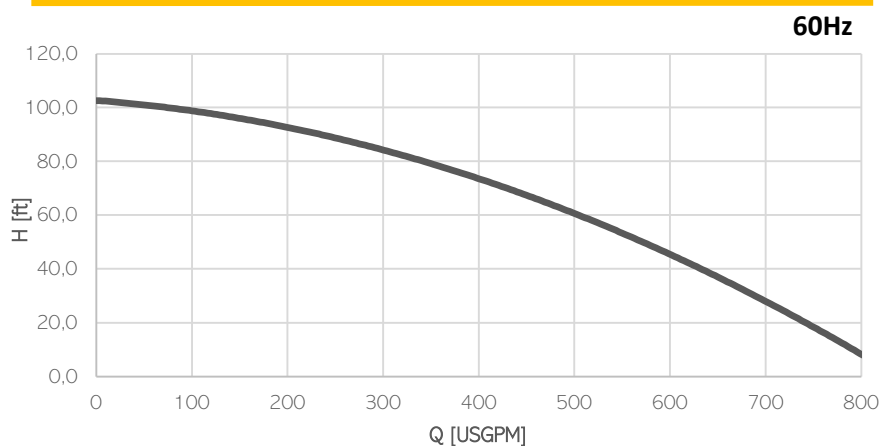

KG
Peso
(cavo escluso)
785 [kg]
1730 [lb]

Motore elettrico

| Classe di isolamento H

Cavo

| 1 x H07RN-F 4G16 lunghezza 20m

Condizioni Operative

| Max temperatura del liquido 35°C
| Immersione minima 1240 mm

Modello	EL25S	
Potenza all'albero [kW HP]	26 35	
Potenza Elettrica [kW HP]	28 38	
Frequenza [Hz]	50	60
Efficienza [%]	47%	47%
Poli	6	6
RPM	970	1164
Tensione [V]	400	460
Assorbimento [A]	55	47
Passaggio Solido [mm in]	35 1.4	
Scarico [DN-PN]	100-10	

Materiali

Parte	Standard
Voluta	Cast Iron EN-GJS500
Corpo	Cast Iron EN-GIL250
Parte di usura	High chrome EN-GJN-HV600 (CH6)
Durezza minima [HB]	550
Albero	Alta resistenza 39NiCrMo3
PH Range	5-10

Tenute e lubrificanti

Versione	EL25S	MG	MS
Lato Motore	LABBRO	MECCANICA	MECCANICA
Lato Girante	LABBRO	LABBRO	MECCANICA
Olio	EP320	ISO32	ISO32